

Schaerer Coffee Celebration

Modell "BC" (Kaffee, Heisswasser, Dampf)

September 2007



Grundausrüstung

Ausgabeeinheiten: Kaffee / Heisswasser / Dampf	1 / 1 / 1
Boiler: Kaffee (3kW) / Heisswasser (6 kW) / Dampf (3 kW)	1 / 1 / 1
Mühlen / DECAF Einwurf	2 / 1
Produktwahlmöglichkeiten	bis 30 verschiedene Produkte

Anschlusswerte

Spannung / Nennleistung / Absicherung	400 V 3NAC / 9.3 kW / 16 A
Wasseranschluss / Wasserablauf	G 1/2" max 3 bar / min. Ø 40mm
Wasserhärte	5°-7° dh / 8°-12° fh

Dimensionen

Breite / Tiefe / Höhe	523 / 617 / 893.5 mm
Gewicht	ca. 55 kg

Leistung Kaffeetassen / Stunde (Richtwerte)

Espresso (Tasse à 50 - 60ml)	200
Kaffee (Tasse à 120ml)	180
Heisswasser (Liter)	30 - 40

Optionen

- 3 Mühlen und DECAF Einwurf
- 4 Mühlen ohne DECAF Einwurf
- Frisch- und Schmutzwassertank
- Einbauset für Satzabwurf unter Buffet
- Umschaltung von Festwasseranschluss auf Wassertank
- Brühbeschleuniger
- Tassenwärmer
- Abschliessbare Bohnenbehälter
- Kurze Bohnenbehälter
- Anschluss an alle handelsüblichen Zahlungs- und Abrechnungssysteme

Vermassung







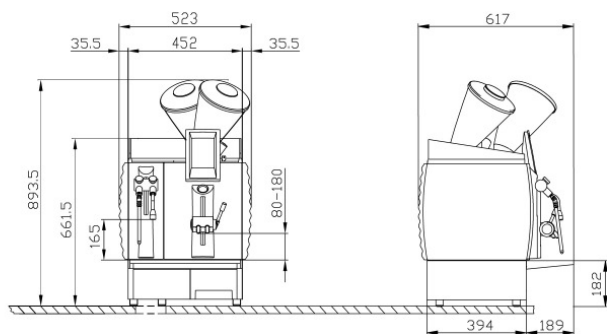

Abbildung / Konfiguration können von offerierten Maschinen abweichen

Farben (frei wählbar)

Abbildungen sind nicht farbverbindlich

-  Blue Mountain, Blau
-  Costa Rica, Silber
-  Brazil, Bronze
-  Kenya, Schwarz
-  Sockel - Chromstahl
-  Sockel - Chromstahl schwarz

M. Schaerer AG

Gewerbstrasse 15
CH - 3302 Moosseedorf
Phone +41 (0)31 858 51 11
Fax +41 (0)31 858 51 40
info@schaerer.com
www.schaerer.com

coffee comes to life

Schaerer Coffee Celebration

Modèle "BC" (Café, Eau chaude, Vapeur)

Septembre 2007



Equipement de base

Ecoulements: Café / Eau chaude / Vapeur	1 / 1 / 1
Chaudière: Café (3kW) / Eau chaude (6kW) / Vapeur (3kW)	1 / 1 / 1
Moulins / Fonction DECAF	2 / 1
Choix des produits	jusqu' à 30 produits programmables

Raccordements

Tension / Alimentation / Disjoncteurs	400 V 3NAC / 9.3 kW / 16 A
Alimentation en eau / Evacuation de l'eau	G ½ " max 3 bar / min. Ø 40mm
Dureté de l'eau recommandée	5°-7° dh / 8°-12° fh

Dimensions

Largeur / Profondeur / Hauteur	523 / 617 / 893.5 mm
Poids	env. 55 kg

Production horaire

Espresso (Tasse de 50 - 60ml)	200
Café (Tasse de 120ml)	180
Eau chaude (litre)	30 - 40

Options

3 moulins et DECAF
4 moulins sans DECAF
Réservoir d'eau fraîche et d'eau sale
Set d'installation pour éjection du marc sous le buffet
Commuter du réservoir d'eau au raccordement de l'eau
Accélérateur de percolation
Chauffe-tasses
Bac à grains verrouillable
Bac à grains court
Connexions à tous les systèmes de décompte du commerce



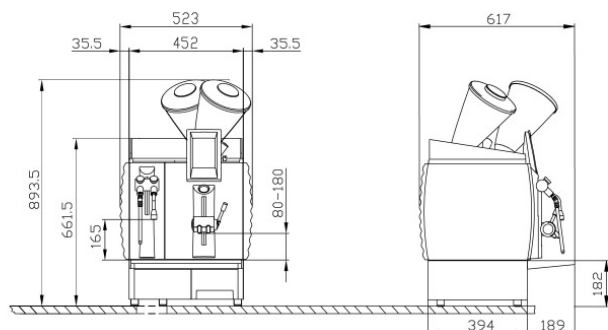



Encombrement



Les illustrations / configurations peuvent différer de la machine offerte.

Couleurs (à choix)

Les illustrations des couleurs peuvent différer

	Blue Mountain, Bleu
	Costa Rica, Argent
	Brazil, Bronze
	Kenya, Noir
	Socle - Acier chromé
	Socle - Acier chromé noir

M. Schaerer SA
Gewerbstrasse 15
CH - 3302 Moosseedorf
Tél +41 (0)31 858 51 11
Fax +41 (0)31 858 51 40
info@schaerer.com
www.schaerer.com

coffee comes to life